



CURVE
BENDS
COUDES
CODOS



DIN

CURVA 90° EM.
BEND 90° EE.
COUDE 90° BD.
CODO 90° EM.

350 D

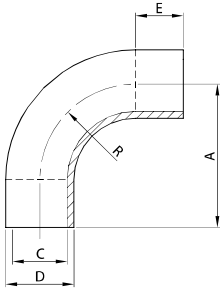

DN	A	C	D	E	R	gr
10	38,0	10,0	12,0	12,0	26,0	30
15	47,0	16,0	18,0	12,0	35,0	55
20	52,0	20,0	22,0	12,0	40,0	60
25	70,0	25,0	28,0	20,0	50,0	110
32	78,0	31,0	34,0	23,0	55,0	160
40	85,0	37,0	40,0	25,0	60,0	215
50	97,0	49,0	52,0	27,0	70,0	300
65	110,0	66,0	70,0	30,0	80,0	570
80	118,0	81,0	85,0	28,0	90,0	780
100	150,0	97,6	101,6	40,0	110,0	1.200
104	150,0	100,0	104,0	40,0	110,0	1.200

CURVA 90° BF./BC. G. MT.
BEND 90° MP./TP. N. ED.
COUDE 90° PF./PC. E. DN.
CODO 90° M./C. T. MD.

353 D

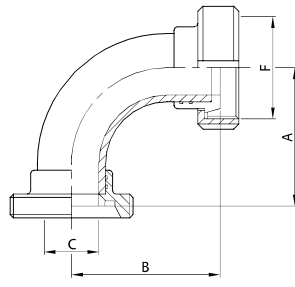

DN	A	B	C	F	gr
25	77,0	77,0	25,0	52-6	487
32	85,0	85,0	31,0	58-6	630
40	91,0	91,0	37,0	65-6	800
50	103,0	103,0	49,0	78-6	1.100
65	117,0	117,0	66,0	95-6	1.785
80	127,0	127,0	81,0	110-4	2.530
100	159,0	159,0	97,6	130-4	3.970
104	159,0	159,0	100,0	130-4	3.970

CURVA 90° BF./BF. MT.
BEND 90° MP./MP. ED.
COUDE 90° PF./PF. DN.
CODO 90° M./M. MD.

354 D

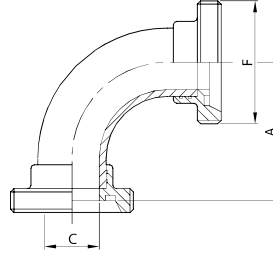

DN	A	C	F	gr
25	77,0	25,0	52-6	374
32	85,0	31,0	58-6	500
40	91,0	37,0	65-6	625
50	103,0	49,0	78-6	860
65	117,0	66,0	95-6	1.330
80	127,0	81,0	110-4	1.980
100	159,0	97,6	130-4	3.200
104	159,0	100,0	130-4	3.200

CURVA 90° EM.
BEND 90° EE.
COUDE 90° BD.
CODO 90° EM.

330 L

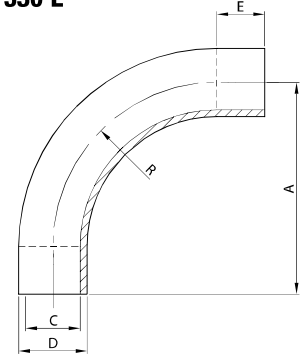

DN	A	C	D	E	R	gr
28	134,0	25,0	28,0	50,0	84,0	220
34	152,0	31,0	34,0	50,0	102,0	310
40	170,0	37,0	40,0	50,0	120,0	410
52	206,0	49,0	52,0	50,0	156,0	650
70	260,0	66,0	70,0	50,0	210,0	1.400
85	305,0	81,0	85,0	50,0	255,0	2.000
101	354,0	97,6	101,6	50,0	304,0	2.800
104	362,0	100,0	104,0	50,0	312,0	2.900

CURVA 180° EL.
BEND 180° PE.
COUDE 180° BL.
CODO 180° EL.

390 L

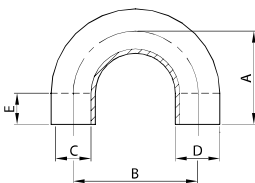

DN	A	B	C	D	E	gr
12	55,0	52,0	9,0	12,0	29,0	60
18	65,0	70,0	15,0	18,0	30,0	110
22	74,0	80,0	19,0	22,0	34,0	120
28	100,0	100,0	25,0	28,0	50,0	185
34	105,0	110,0	31,0	34,0	50,0	240
40	110,0	120,0	37,0	40,0	50,0	350
52	120,0	140,0	49,0	52,0	50,0	410
70	135,0	170,0	66,0	70,0	50,0	970
85	140,0	180,0	81,0	85,0	50,0	1.500
101	150,0	220,0	97,6	101,6	40,0	2.400
104	150,0	220,0	100,0	104,0	40,0	2.400

CURVA 180° BF./BF. MT.
BEND 180° MP./MP. ED.
COUDE 180° PF./PF. DN.
CODO 180° M./M. MD.

391 D

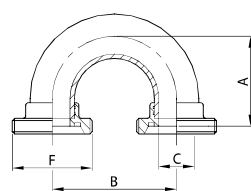

DN	A	B	C	F	gr
25	107,0	100,0	25,0	52-6	450
32	112,0	110,0	31,0	58-6	580
40	116,0	120,0	37,0	65-6	770
50	126,0	140,0	49,0	78-6	970
65	142,0	170,0	66,0	95-6	1.730
80	149,0	180,0	81,0	110-4	2.700
100	169,0	220,0	97,6	130-4	4.400
104	169,0	220,0	100,0	130-4	4.400

CURVA 180° BF./BC. G. MT.
BEND 180° MP./TP. N. ED.
COUDE 180° PF./PC. E. DN.
CODO 180° M./C. T. MD.

393 D

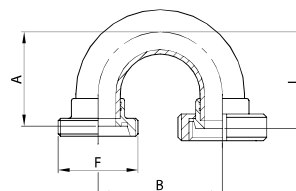

DN	A	B	F	L	gr
25	107,0	100,0	52-6	107,0	562
32	112,0	110,0	58-6	112,0	710
40	116,0	120,0	65-6	116,0	995
50	126,0	140,0	78-6	126,0	1.210
65	142,0	170,0	95-6	142,0	2.185
80	149,0	180,0	110-4	149,0	3.250
100	169,0	220,0	130-4	169,0	5.170
104	169,0	220,0	130-4	169,0	5.170